

2021-09-22

**REQUEST FOR QUOTATION
VARIOUS FENCING REPLACEMENT – UNIT RATES
RFQ 32 (2021-09)**

The Toronto Zoo invites you to submit a non-exclusive multi-year quotation to provide labour, tools, materials and equipment to complete various fencing installs throughout the Toronto Zoo site. All work is to be completed in accordance with the drawings and specifications in the Request for Quotation (RFQ).

The work shall commence as soon as possible once the project is awarded and a Purchase Order has been issued.

The Quotation package includes Instructions, Terms & Conditions, Requirements, Drawings, and Forms. Quoted prices shall remain in effect for a period of ninety (90) days from the Quotation due date.

Site Meeting: A site meeting will be held by appointment only. The site meeting will be limited to one (1) representative per bidder. Bidders are to request an appointment by emailing pvasilopoulos@torontozoo.ca and jjakaran@torontozoo.ca.

The Board of Management of the Toronto Zoo reserves the right to reject any or all quotes or to accept any quote, should it deem such an action to be in its interests.

Yours truly,

Alia Lee
Director, Finance & Technology

Table of Contents

SECTION	DESCRIPTION	PAGE (S)
RFP LETTER	Invitation Letter	1
T.O.C.	Table of Contents	2
1.0	Instructions	3
2.0	Terms and Conditions	6
3.0	Project Requirements	9
4.0	Submission Forms	13
	Submission Label	23
	Notice of No Bid	24
Appendix A	List of sub-contractors	25
Appendix B	Contractor's Questionnaire Form	26
	DRAWINGS & SPECIFICATIONS	
	Barrier Fencing – Amur Tigers	
	Cantilevered Slide Gate – 22' opening	
	Exclusion Fence - Service Gate Detail	
	Exclusion Fence & Swing Gate Detail	
	Paddock Fencing Details	
	Perimeter Fencing – Parking Lot 3	
	Perimeter Fence Spec	
	Barrier Fencing – Sumatran Tigers	

1.0 INSTRUCTIONS

- 1.1 Ensure that you have received all **twenty-eight (28)** pages, **eight (8)** drawings & specifications, and attachments of the RFQ package.
- 1.2 A site meeting will be held by appointment only. The site meeting will be limited to one (1) representative per bidder. Bidders are to request an appointment by emailing pvasilopoulos@torontozoo.ca.
- 1.3 Your quotation must be completed, and received by

Thursday, 2021-10-07, 1200 hours (noon, local time)

Submission – Temporary process - In view of the current situation with COVID 19 and to limit personal interaction, on a temporary basis submissions for this Request for Proposal can be submitted electronically by email in a PDF file, prior to the submission deadline to the following email address

bids@torontozoo.ca

and note the following:

Subject of the file to be: RFQ# - Title of RFQ – Vendor name.

b. Amendments to a Proposal may be submitted via the same methods, at any time prior to the Closing Time.

c. It is the Supplier's sole responsibility to ensure its Bid is received by the Submission Deadline in accordance with the requirements of this RFP. The receipt of Bids can be delayed due to a number of factors including "internet traffic", file transfer size and transmission speed. The Supplier should allow sufficient time to download, complete and upload, as applicable, the submission forms comprising its Bid and any attachments.

A Bid will only be considered to be submitted once it has been received by the Toronto Zoo. The time of such receipt is reflected by the time received stamped by the Toronto Zoo's email application

- 1.4 Quotations must not be submitted by facsimile,
- 1.5 Show itemized cost of HST if applicable.
- 1.6 Toronto Zoo reserves the right to award in whole or in part on the basis of the bids received, Lump Sum Price or Breakdown Price.
- 1.7 All Prices submitted shall be quoted in Canadian currency.
- 1.8 Use the attached submission label, when you submit your response in a sealed envelope or package and deliver to the Toronto Zoo. (N/A)
- 1.9 Quotation prices shall remain in effect for a period of ninety (90) days from the Quotation due date.

1.10 No Guarantee of Volume of Work or Exclusivity of Contract – Toronto Zoo makes no guarantee of the value or volume of work to be assigned to the successful bidder. The Contract will not be an exclusive contract for the provision of the described Deliverables. The Toronto Zoo may contract with others for goods and services the same as or similar to the Deliverables or may obtain such goods and services internally.

1.11 Upon Award of this RFQ, the Successful Bidder and the Toronto Zoo will have an Agreement for a period of one (1) year with options to renew for two (2) additional one-year periods, all in accordance with the terms, conditions, and specifications contained in this RFQ and any applicable Toronto Zoo policy.

The decision to renew the Agreement for any option term will be at the sole discretion of the Toronto Zoo and will be decided at least four (4) months in advance.

All terms and conditions of the Agreement shall remain in effect and continue during the optional year(s), with the exception of any price adjustment.

The Toronto Zoo may take into consideration the following when making its decision to exercise any option year:

- A. Available budget;
- B. The annual price adjustment;
- C. Successful Bidder performance during the contract including meeting timeliness and delivery of Services; and
- D. Operational needs

Included in the decision to accept any option year(s) of the Agreement, is a price adjustment annually effective applied after the expiry date in accordance with the annual Consumer Price Index (CPI), (CPI Index-All Items-Toronto) for a 12-month period, using the most current CPI released month at the time of the first option year renewal, conducted by the Board for the Services included herein.

All subsequent option year renewals will be evaluated using the same CPI release month exercised during option year one (1), of the new year being exercised. All terms and conditions of the Agreement shall remain the same and continue during the extended Term.

For the purposes of the evaluation and award, there will be a 3% CPI increase applied annually to the total annual cost submitted by the Bidder.

1.12 Include product information, samples, and pictures, as necessary.

1.13 If applicable, suggested alternative products are acceptable, however all such products must be quoted separately and should not replace the Toronto Zoo requested product, work or service.

1.14 It is the responsibility of the Bidder to understand all aspects of the RFQ and to obtain clarification if necessary before submitting their quotation.

For any questions concerning this RFQ, must be forwarded by the end of the day Friday, **2021-10-01** to: contact:

2.0 TERMS AND CONDITIONS

- 2.1 Definitions:** Wherever used in the Request for Quotation the word “**Board**” means the Board of Management of the Toronto Zoo and the word “**Vendor**” or “**Contractor**” means the person or persons or Corporation to whom the purchase order is issued.
- 2.2 Vendor Assurance:** Unless otherwise stated, the goods, material, articles, equipment, work or services, specified or called for in or under this Quotation, shall be delivered or completely performed, as the case may be, by the Vendor as soon as possible and in any event within the period set out herein as the guaranteed period of delivery or completion.
- 2.3 Country of Origin:** Wherever possible, the goods, services, materials, articles or equipment, specified or called for in or under this Quotation, shall be of Canadian origin and manufacture.
- 2.4 Delivery:** The prices stated in this Quotation cover the services, material, articles or equipment referred to herein, being delivered F.O.B. destination, freight, express, duty and all other charges prepaid, unless otherwise indicated herein. A detailed delivery ticket or piece tally, showing the exact quantity of goods, material, articles or equipment shall accompany each delivery. A receiver’s receipt shall not bind the Board to accept the goods, material, articles or equipment covered thereby, or the particulars of the delivery ticket or piece tally therefore. The Vendor shall not be entitled to any interest upon any bill due to delay in its approval by the CEO of the Toronto Zoo or his designate.
- 2.5 Invoicing:** Unless otherwise indicated herein, the prices stated are payable in Canadian Funds at the head office of the Board. Any Harmonized Sales Tax (HST) applicable shall be shown as a separate item. The Vendor’s HST/Business registration number must be indicated on the invoice.

The Vendor shall clearly show any special charges such as packaging and freight, where applicable, as separate items on the invoice.

Payments to non-resident Vendors may be subject to withholding taxes under the Income Tax Act (Canada). Unless a non-resident Vendor provides the Board with a letter from Revenue Canada, Taxation waiving the withholding requirements, the Board will withhold the taxes it determines are required under the Income Tax Act (Canada).

- 2.6 Notice of Delivery:** The Vendor shall notify the Purchasing Agent of the Board at the address given for the mailing of invoices, in writing as soon as possible of the details of the shipment of the goods, materials, articles or equipment.
- 2.7 Right to Cancel:** The Board shall have the right to cancel at any time this Quotation or any contract or any part of any contract resulting from this Quotation in respect of the goods, material, articles, equipment, work or services set out in this Quotation or any such contract or part of such contract, not delivered or performed at the time of such cancellation, and the Board will not be responsible to make any payments in respect of any such goods, materials, articles, equipment, work or services and shall not incur any liability whatsoever in respect thereto.

In the event that the Vendor fails or neglects by any act or omission to comply with any of the conditions set out herein, this Quotation or any contract resulting from this Quotation may be unconditionally cancelled by the Board without notice to the Vendor.

- 2.8 Official Agreement:** No verbal arrangement or agreement, relating to the goods, material, articles, equipment, work or services, specified or called for under this Quotation, will be considered binding, and every notice advice or other communication pertaining thereto, must be in writing and signed by a duly authorized person.
- 2.9 Worker's Rights:** The Vendor shall comply with the conditions of the Board relating to Worker's Rights, a copy of which is available on application to the Manager, Fair Wage and Labour Trades Office, City of Toronto, 18th Floor, West Tower, City Hall, Toronto, Ontario, M5H 2N2 or by phone at 416-392-7300.
- 2.10 Indemnity:** The Vendor shall at all times well and truly save, defend, keep harmless and fully indemnify the Board, the City of Toronto, Toronto Region and Conservation Authority and their servants, employees, officers or agents, hereinafter called the "Indemnities", from and against all actions, suits, claims, demands, losses, costs, charges, damages, and expenses, brought or made against or incurred by the Indemnities, its or their servants, officers, employees, agents or invitees in any way relating, directly or indirectly, to goods, material, articles or equipment supplied or to be supplied, or to the supplying of goods or services, pursuant to this Quotation, or any other claim, action, suit, demand, loss, cost, charge, damage or expense relating to copyright, trademark or patent with regard directly or indirectly with any such goods, services, material, articles or equipment or the supply or performance thereof.
- 2.11 Liability for Acts of Vendor Employees, Contractors or Agents:** The Vendor acknowledges responsibility and accepts liability for the acts of any of its employees, contractors and agents while on Toronto Zoo property. The Toronto Zoo reserves the right to request background checks for any individual providing the services requested on behalf of the Vendor.
- 2.12 Guaranty of Quotation:** All goods, material, articles, equipment, work or services, specified or called for in or under this Quotation, shall be supplied or performed at the price or process and on the basis set forth or referred to in and in accordance with the Offer and this Quotation. The basis on which this Quotation is given shall include any specifications, plans, price schedules, samples, addenda or other details pertaining thereto, or provided in connection therewith.
- 2.13 Right of Notice:** Any notice that the Board may be required or desire to give to the Vendor shall for all purposes to be deemed to have been sufficiently and properly given and afforded by registered mail addressed to the Vendor at the address shown for the Vendor on this form and shall therefore be presumed to have been received by the Vendor on the third day following such registration.
- 2.14 Formal Contract:** The Vendor may be required and shall, if requested by the solicitor for the Board so to do, to execute and enter into a formal contract that is satisfactory to the solicitor for the Board, in order to document the contract resulting from this Quotation and to embody indemnity and related provisions that in the opinion of such solicitor are required to protect the Board.

-
- 2.15 Charity Status:** The Toronto Zoo is a registered charitable organization (registration #BN 119216398RR0001) and accordingly may be eligible for preferred pricing which should be reflected in the Quotation as submitted.
- 2.16 Performance Evaluation:** The Contractor's performance will be evaluated by the Chief Executive Officer and/or Chief Executive Officer's Representative during the Contract and at the end of the Contract. In the event that the Contractor's performance is considered unsatisfactory by the Chief Executive Officer and/or Chief Executive Officer's Representative, the Contractor and/or its affiliates may become ineligible from bidding on future contracts issued by the Board.

3.0 PROJECT REQUIREMENTS

The work shall commence once the project has been awarded and a Purchase Order issued. The scope of work includes supply of all labour, tools, materials and equipment necessary to complete the work. All work is to be completed in accordance with the drawings and specifications in the Request for Quotation (RFQ). The contractor is responsible for all pricing and all other arrangements with all subcontractors as required.

3.1 SCOPE OF WORK

1. Supply all labour, tools, materials and equipment to complete the work as outlined in the quotation documents, drawings and specifications.
2. All work to be completed in accordance with applicable codes (e.g. Building Code, Electrical Code, Fire Code, etc.)
3. The contractor shall supply the Zoo with copies of relevant certificates and licences for all workers prior to commencement of work.
4. All measurements to be site verified.
5. Protect all areas not affected by the work. Any damage to these areas will be the responsibility of the contractor to rectify.
6. Clean the work area and remove all debris from site on a daily basis.
7. Excess material will be stored on the Toronto Zoo site for future use. Toronto Zoo staff will designate a suitable area for stockpiling of additional material.
8. The contractor is required to provide closeout documents including but not limited to as built drawings, warranty, and inspection certificates.
9. Paddock Fencing
 - a. Remove existing perimeter paddock fencing (minimum 100'). Dispose off-site.
 - b. Install perimeter paddock fencing (minimum 100') as described in drawings.
10. Exclusion Fencing
 - a. Install exclusion fencing (minimum 100') as described in drawings.
11. Exclusion Fencing – Service Gate
 - a. Install new exclusion fencing service gate as described in drawings.
12. Exclusion Fencing – Single Swing Gate
 - a. Install new exclusion fencing single swing gate as described in drawings.
13. Perimeter Fencing

-
- a. Install perimeter fencing (minimum 100') as described in drawings.
14. Perimeter Fencing - Gate
 - a. Install perimeter fencing gate as described in drawings.
 15. Perimeter Fencing – Parking Lot 3
 - a. Install perimeter fencing (approximately 2500 linear feet) as described in drawings.
 16. Barrier Fencing – Amur Tigers
 - a. Install new barrier fencing (minimum 100') as described in drawings.
 17. Barrier Fencing w/ Double Outrigger – Amur Tigers
 - a. Install new barrier fencing w/ double outriggers (minimum 100') as described in drawings.
 18. Barrier Fencing Gate – Amur Tigers
 - a. Install new barrier fencing gate as described in drawings.
 19. Barrier Fencing – Sumatran Tigers
 - a. Install new barrier fencing (minimum 100') as described in drawings.
 - i. New barrier fencing is to **also include** a layer of ½" x ½" welded wire mesh galv., 8' height, overlaid onto the of 6" x 6" welded wire mesh galv. Hogtie panels together.
 20. Barrier Fencing w/ Double Outrigger – Sumatran Tigers
 - a. Install new barrier fencing w/ double outriggers (minimum 100') as described in drawings.
 - i. New barrier fencing is to **also include** a layer of ½" x ½" welded wire mesh galv., 8' height, overlaid onto the of 6" x 6" welded wire mesh galv. Hogtie panels together.
 21. Barrier Fencing Gate – Sumatran Tigers
 - a. Install new barrier fencing gate as described in drawings.
 - i. New barrier fencing gate is to **also include** a layer of ½" x ½" welded wire mesh galv., 8' height, overlaid onto the of 6" x 6" welded wire mesh galv. Hogtie panels together.
 22. Cantilevered Slide Gate – 22' opening
 - a. Install new cantilevered sliding gate with operator for a 22' opening as described in drawings.
 - i. The gate is to slide on the inside of the fence.
 - ii. The gate is to have integrated internal tracks.
 - iii. New chainlink to match perimeter fencing.

- iv. Posts to be schedule 40, galvanized and black powder coated.
- v. Gate to be galvanized and black powder coated.
- vi. Install Liftmaster SL585U or equivalent operator suitable for heavy duty industrial use.
 1. Operator to be gear driven, 1hp, and have reflective photoeye or similar for monitoring.
 2. Operator must have a minimum 1 year warranty on parts and labour.
- vii. Install new loops to notify of vehicle presence.
- viii. Gate to be 8' high.
- ix. Install a manual open and close switch which can be locked out by a key. The lock cylinder must be Best compatible.

The Contractor is responsible for all pricing and all other arrangements with their subcontractors as required.

3.2 CONTRACTOR RESPONSIBILITIES

1. Regular meetings/communication with the Toronto Zoo Project Team to review project status and to discuss issues that may arise during the project.
2. Provide samples, mock ups, etc. as required to the Project Team. A sample for the mud bank finish is required, prior to complete application. Sample is to be approved by the Toronto Zoo.
3. Provide product information, MSDS sheets and colour samples to the Project Team prior to start of the work where applicable.
4. Provide the Zoo with a five (5) year warranty upon completion of the project.
5. Protect adjacent areas not included in the project. Any damage caused will be the responsibility of the contractor to rectify at no additional cost to the Zoo.
6. Clean-up the work area daily and make good any damage caused as a result of the work.
7. Secure the work site and provide construction signs and barriers to prevent injury to Zoo personnel and the public who will require access to the surrounding space during the work.
8. All electric current required for the work shall be provided or furnished by the Contractor. All temporary connections for electricity shall be subject to the approval of the Owner. All temporary lines will be furnished, installed, connected, and maintained by the Contractor in a professional manner satisfactory to the Owner and shall be removed by the Contractor in like manner upon completion of the work.
9. Upon award of contract, Contractor is to finish all work, including clean up and demobilization by the completion date specified.
10. Submit all shop drawings for review and approval prior to start of fabrication. Review of shop drawings shall not mean that the Toronto Zoo approves detail design inherent in shop drawings, responsibility for which shall remain with the

Contractor submitting same, and such review shall not relieve the Contractor of his responsibility for errors or omissions in shop drawings or of his responsibility for meeting all requirements of the subcontract documents.

11. Submit close out documents as requested. Include warranties and “As built” drawings.

3.3 SAFETY SPECIFICATIONS

1. It is the responsibility of the Contractor to protect the site as required during construction.
2. Ensure that awareness of public safety is considered and protect visitors in the vicinity during the construction period.
3. All necessary personal protective equipment must be worn at all times and MSDS sheets must be available on site as required.
4. The contractor is to abide by applicable Toronto Zoo Health & Safety Policies, the Ontario Health and Safety Acts, the Ontario Building Code and all other applicable codes including the Fire Codes.
 - i. SAFE-002 Health & Safety Hazard Reporting
 - ii. SAFE-017 Contractors Safety
 - iii. SAFE-018 Vehicles on Site
 - iv. SAFE-007 Working in Confined Space
 - v. SAFE-025 Hot Work
 - vi. SAFE-013 Equipment Lockout/Tagout
5. The contractor is to abide by the Toronto Zoo’s Commitment to the City of Toronto’s Corporate Smog Alert Response Plan
6. It is the responsibility of the Contractor to ensure that the work site is properly protected at all times. All work sites must be marked and hoarded adequately with construction signs posted to secure and isolate the work site from the public or other personnel that have access to the area.

3.4 OTHER INFORMATION

The successful bidder must demonstrate the ability to complete the work to standards acceptable to the Zoo and prove past performance in the completion of similar types of work for other clients by providing relevant examples of work and references. The successful bidder must also demonstrate and guarantee that they can produce the work in the allotted time.

4.0 SUBMISSION FORMS:

I/We, hereby, submit the Quotation and will comply with all terms, conditions, specifications and drawings (when provided) as set out within the Board’s Quotation.

I/We, hereby, have received, allowed for and included as part of our submission all issued Addendum numbered _____.

This form must be completed, properly signed and received on or before the date and time specified or your Quotation will not be considered. Quotation prices shall remain in effect for a period of ninety (90) days from the Quotation due date.

The Board of Management of the Toronto Zoo reserves the right to reject any or all Quotations or to accept any Quotation, should it deem such action to be in its interests.

By signing and submitting this FORM, you are agreeing to the release of your quotation information, as deemed necessary by the Board, in order to conduct business associated with this quotation or project.

COMPANY INFORMATION	
Company Name:	
Name of authorized Signing Officer	Title:
Signature of authorized Signing Officer:	Date:
Contact Name:	Title:
Address:	
Telephone #:	Fax #:
Email:	Web Site:
HST #:	

4.1 QUOTATION PRICING - LUMP SUM PRICE

DESCRIPTION	Price complete, excluding HST
To provide all labour, tools, materials and equipment necessary to complete the installation of perimeter fencing at the Parking Lot 3 at the Toronto Zoo as specified in the quotation documents, drawings & specifications of the RFQ package.	\$
HST	\$
Total	\$

COMMITMENT TO DELIVER	YES / NO
The expected date of award is the week of 2021-10-11 . Please confirm that you are able to commence the work no earlier than Monday, 2021-10-18 , and be completed by Friday, 2021-12-17 . Contractor will have access to the project site from 0800 hours – 1700 hours (8:00am-5:00pm) daily.	

4.2 UNIT PRICES

- 5 The quantities listed for which unit prices are required are annual estimates only and do not constitute a warranty, or guarantee by the Zoo as the actual quantities to be purchased may be more or less. The quantities are to be used for the purpose of comparison Quotations. The Zoo expressly reserves the right to increase or decrease the quantities, as need dictates.
- 6
- 7 **in the evnt that additional goods or services are required it will be upon mutual agreement of the Toronto Zoo and selected bidder, charged at the unit prices provided in this pricing submission form.**
- 8 All unit pricing must be firm for one (1) year, the initial term of the Contract

The following are our Unit Prices for the work listed hereunder. Such work and rates are NOT included in our Lump Sum Price in item 4.1,. The non-exclusive unit rates are to include all additional costs associated with mobilization/ demobilization, labour, material, warranty, taxes (excluding Harmonized Sales Tax), charges, payroll, burden and profit, etc. to facilitate the work listed below.

DESCRIPTION OF UNIT PRICE WORK	UNIT RATE	Estimate quantity of unit rate	2021 UNITRATE	2022 UNIT RATE Percentage increase of first option year over initial 2021 year	2023 UNIT RATE Percentage increase of second option year over option 2022 year
Install <u>PERIMETER Paddock</u> fencing at the Toronto Zoo as specified in the quotation documents, drawings & specifications of the RFQ package. (/LF	0-100 LF			

<p>Install <u>PERIMETER Paddock</u> fencing at the Toronto Zoo as specified in the quotation documents, drawings & specifications of the RFQ package</p>	<p>/LF</p>	<p>101-500 LF</p>			
<p>Install <u>PERIMETER Paddock</u> fencing at the Toronto Zoo as specified in the quotation documents, drawings & specifications of the RFQ package.</p>	<p>/LF</p>	<p>501-above LF</p>			
<p>Install <u>PERIMETER Paddock</u> fencing at the Toronto Zoo as specified in the quotation documents, drawings & specifications of the RFQ package.</p>	<p>/LF</p>	<p>0-100 LF</p>			
<p>Install <u>PERIMETER Paddock</u> fencing at the Toronto Zoo as specified in the quotation documents, drawings & specifications of the RFQ package.</p>	<p>/LF</p>	<p>101-500 LF</p>			
<p>Install <u>PERIMETER Paddock</u> fencing at the Toronto Zoo as specified in the quotation documents, drawings & specifications of the RFQ package.</p>	<p>/LF</p>	<p>501-above LF</p>			

<p>Install EXCLUSION fencing at the Toronto Zoo as specified in the quotation documents, drawings & specifications of the RFQ package.</p>	<p>/LF</p>	<p>0-100 LF</p>			
<p>Install EXCLUSION fencing at the Toronto Zoo as specified in the quotation documents, drawings & specifications of the RFQ package.</p>	<p>/LF</p>	<p>101-500 LF</p>			
<p>Install EXCLUSION fencing at the Toronto Zoo as specified in the quotation documents, drawings & specifications of the RFQ package. (501-above linear feet)</p>	<p>/LF</p>	<p>501-above LF</p>			
<p>Install EXCLUSION fencing – SERVICE GATE at the Toronto Zoo as specified in the quotation documents, drawings & specifications of the RFQ package.</p>	<p>/EA</p>				
<p>Install EXCLUSION fencing – SINGLE SWING GATE at the Toronto Zoo as specified in the quotation documents, drawings & specifications of the RFQ package.</p>	<p>/EA</p>				

<p>Install <u>BARRIER</u> fencing – <u>AMUR TIGERS</u> at the Toronto Zoo as specified in the quotation documents, drawings & specifications of the RFQ package.</p>	<p>/LF</p>	<p>0-100 LF</p>			
<p>Install <u>BARRIER</u> fencing – <u>AMUR TIGERS</u> at the Toronto Zoo as specified in the quotation documents, drawings & specifications of the RFQ package.</p>	<p>/LF</p>	<p>101-500 LF</p>			
<p>Install <u>BARRIER</u> fencing – <u>AMUR TIGERS</u> at the Toronto Zoo as specified in the quotation documents, drawings & specifications of the RFQ package.</p>	<p>/LF</p>	<p>501-above LF</p>			
<p>Install <u>BARRIER</u> fencing <u>W/ DOUBLE OUTRIGGER</u> – <u>AMUR TIGERS</u> at the Toronto Zoo as specified in the quotation documents, drawings & specifications of the RFQ package.</p>	<p>/LF</p>	<p>100 LF</p>			
<p>Install <u>BARRIER</u> fencing <u>W/ DOUBLE OUTRIGGER</u> – <u>AMUR TIGERS</u> at the Toronto Zoo as specified in the quotation documents, drawings & specifications of the RFQ package.</p>	<p>/LF</p>	<p>101-500 LF</p>			

<p>Install BARRIER fencing W/ DOUBLE OUTRIGGER – AMUR TIGERS at the Toronto Zoo as specified in the quotation documents, drawings & specifications of the RFQ package.</p>	<p>/LF</p>	<p>501-above LF</p>			
<p>Install BARRIER fencing GATE – AMUR TIGERS at the Toronto Zoo as specified in the quotation documents, drawings & specifications of the RFQ package.</p>	<p>/EA</p>				
<p>Install BARRIER fencing – SUMATRAN TIGERS at the Toronto Zoo as specified in the quotation documents, drawings & specifications of the RFQ package. (</p>	<p>/LF</p>	<p>100 LF minimum</p>			
<p>Install BARRIER fencing – SUMATRAN TIGERS at the Toronto Zoo as specified in the quotation documents, drawings & specifications of the RFQ package</p>	<p>/LF</p>	<p>. 101-500 LF</p>			
<p>Install BARRIER fencing – SUMATRAN TIGERS at the Toronto Zoo as specified in the quotation documents, drawings & specifications of the RFQ package.</p>	<p>/LF</p>	<p>501-above LF</p>			

<p>Install <u>BARRIER</u> fencing <u>W/ DOUBLE OUTRIGGER</u> – <u>SUMATRAN TIGERS</u> at the Toronto Zoo as specified in the quotation documents, drawings & specifications of the RFQ package. (</p>	<p>/LF</p>	<p>100 LF minimum</p>			
<p>Install <u>BARRIER</u> fencing <u>W/ DOUBLE OUTRIGGER</u> – <u>SUMATRAN TIGERS</u> at the Toronto Zoo as specified in the quotation documents, drawings & specifications of the RFQ package</p>	<p>/LF</p>	<p>101-500 LF</p>			
<p>Install <u>BARRIER</u> fencing <u>W/ DOUBLE OUTRIGGER</u> – <u>SUMATRAN TIGERS</u> at the Toronto Zoo as specified in the quotation documents, drawings & specifications of the RFQ package.</p>	<p>/LF</p>	<p>501-above LF</p>			
<p>Install <u>BARRIER</u> fencing <u>GATE</u> – <u>SUMATRAN TIGERS</u> at the Toronto Zoo as specified in the quotation documents, drawings & specifications of the RFQ package.</p>	<p>/EA</p>				
<p>Install <u>CANTILEVERED SLIDE GATE</u> – <u>22' OPENING</u> at the Toronto Zoo as specified in the quotation documents, drawings & specifications of the RFQ package.</p>	<p>/EA</p>				

	Chief Installer (each) rate for new installation during normal business hours Monday through Friday 7:30am to 5:30pm	/HR				
	Chief Installer (each) rate for new installation after normal business hours Monday through Friday 5:30pm to 7:30am	/HR				
	Labourer (each) rate for new installation during normal business hours Monday through Friday 7:30am to 5:30pm	/HR				
	Labourer (each) rate for new installation after normal business hours Monday through Friday 5:30pm to 7:30am	/HR				

WARRANTY	Specify
Please confirm five (5) year warranty upon completion of the project.	

DISCOUNT	Discount and/or Other	Days
Discount allowed for prompt payment and period within which invoice must be paid to qualify.	%	
Charity Status: The Toronto Zoo is a registered charitable organization (registration #BN 119216398RR0001) and accordingly may be eligible for preferred pricing which should be reflected in the Quotation as submitted.		

Name of Firm:	
----------------------	--

SUBMISSION LABEL (N/A)

This address label should be printed and affixed to the front of your sealed tender, quotation and proposal envelope/package submission. Toronto Zoo will not be held responsible for envelopes and packages that are not properly labelled or submitted to an address other than the one listed on this label.

Vendor Name _____

RFQ 32 (2021-09) – VARIOUS FENCING REPLACEMENT

Due Date: Thursday, 2021-10-07, 1200 hours (noon, local time)

TO BE RETURNED TO

**TORONTO ZOO
C/O SUPERVISOR, PURCHASING & SUPPLY
ADMINISTRATIVE SUPPORT CENTRE
361A OLD FINCH AVE.
TORONTO, ONTARIO
M1B 5K7**

NOTICE OF NO BID

INSTRUCTIONS:

It is important to the Toronto Zoo to receive a reply from all invited bidders. If you are unable, or do not wish to submit a bid, please complete the following portions of this form. State your reason for not bidding by checking the applicable box(es) or by explaining briefly in the space provided. It is not necessary to return any other Request for Proposal/Quotation/Tender documents or forms. Please just return this completed form by fax or by mail prior to the official closing date. **Purchasing and Supply Fax Number: (416) 392-6711.**

A Proposal/Quotation/Tender is not submitted for the following reason(s):	
Project/quantity too large.	Project/quantity too small.
We do not offer services or commodities to these requirements	Cannot meet delivery or completion requirement
We do not offer this service or commodity.	Agreements with other company do not permit us to sell directly.
Cannot handle due to present commitments.	Licensing restrictions
Unable to bid competitively.	We do not wish to bid on this service or commodity in the future.
Insufficient information to prepare quote/proposal/tender	Specifications are not sufficiently defined
We are unable to meet bonding or insurance requirements.	

<u>Other reasons or additional comments (please explain):</u>

Company Name:	
Address	
Contact Person:	
Signature of Company Representative:	
Date:	
Phone Number:	
Email address	
Fax Number:	

APPENDIX A – LIST OF SUB-CONTRACTOR

The Bidder proposes to sublet the following portions of the Work to the persons firms or corporations indicated. The Bidder (Contractor) is responsible for all pricing with all subcontractors.

The Bidder submits that in proposing the under mentioned subcontractors, the Bidder has consulted each and have ascertained to our completed satisfaction that those names are fully acquainted with the extent and nature of the work and that they will execute their work with the requirements of the contract documents.

Work or services to be provided	Name and address of sub-contractor or person	Telephone

Name of Bidder:	
------------------------	--

APPENDIX B - CONTRACTOR’S QUESTIONNAIRE FORM

1. Registered Name

Provide the registered name of the respondent

2. Parent Company

Provide the following information for the respondent’s parent company

Name:	
Address:	
Phone Number:	
Fax Number:	
Website Address:	
Subsidiaries:	

3. Core Businesses

If applicable, list the other core businesses that the respondent is involved in, in descending priority. Attach additional sheets as required

<u>Other Core Business</u>	<u>No. of Years in the Business</u>

4. Years of Experience

State the number of years’ experience providing similar services to the project.

Years of Experience

5. Relevant Experience and References

List relevant experience and client references that demonstrate the respondent’s experience in the last five (5) years. Attach additional sheets as required.

Project Reference One:			
Client / Company Name:			
Representative for the		Phone No.	

Client:		Email Address:	
Location of Work:			
Nature / Scope of Work:			
Contract Dollar Value:			

Date and Length of Contract:	
Provide the names of Assigned Staff:	

Project Reference Two:			
Client / Company Name:			
Representative for the Client:		Phone No.	
		Email Address:	
Location of Work:			
Nature / Scope of Work:			
Contract Dollar Value:			
Date and Length of Contract:			
Provide the names of Assigned Staff:			

Project Reference Three:			
Client / Company Name:			
Representative for the Client:		Phone No.	
		Email Address:	
Location of Work:			
Nature / Scope of Work:			
Contract Dollar Value:			
Date and Length of Contract:			
Provide the names of Assigned Staff:			

6. Key Personnel

Identify all key personnel, their alternates, and their proposed position (Project Manager, Site Superintendent, Safety Coordinator, Foreman, etc.) for providing the services under this RFQ. Additionally, the representative who will be assigned to the Toronto Zoo as a single point of contact for operational matters shall be identified.

Personnel	Position Description	Years' Experience

7. Staff Training / Certification

Attach brief staff profile for all key personnel, and their alternates, that are listed in the organizational chart requested above.

8. Subcontractors

If the respondent is utilizing subcontractors, provide a breakdown of roles and responsibilities to be assigned to subcontractors. Include past experience with identified subcontractors.

Subcontractor Name:	
Roles and Responsibilities to be Assigned:	
Past Project Experience with Subcontractor:	

Subcontractor Name:	
Roles and Responsibilities to be Assigned:	
Past Project Experience with Subcontractor:	

(Repeat above for each identified subcontractor)

9. Work Plan

Each respondent should provide their methodology (maximum 2 pages) for how they plan to undertake the scope of work. The following tasks shall be included, at minimum, and the Contractor shall identify any other tasks necessary to complete the work described in this RFQ:

- (a) Minimizing disruption to Toronto Zoo guests and staff;
- (b) Providing safe movement for workers, vehicles and guests;

10. Equipment

Please identify the type of equipment and a brief description of the equipment to be used to complete the work within this RFQ.

Type of Equipment	Description of Usage

Name of Firm:	
----------------------	--

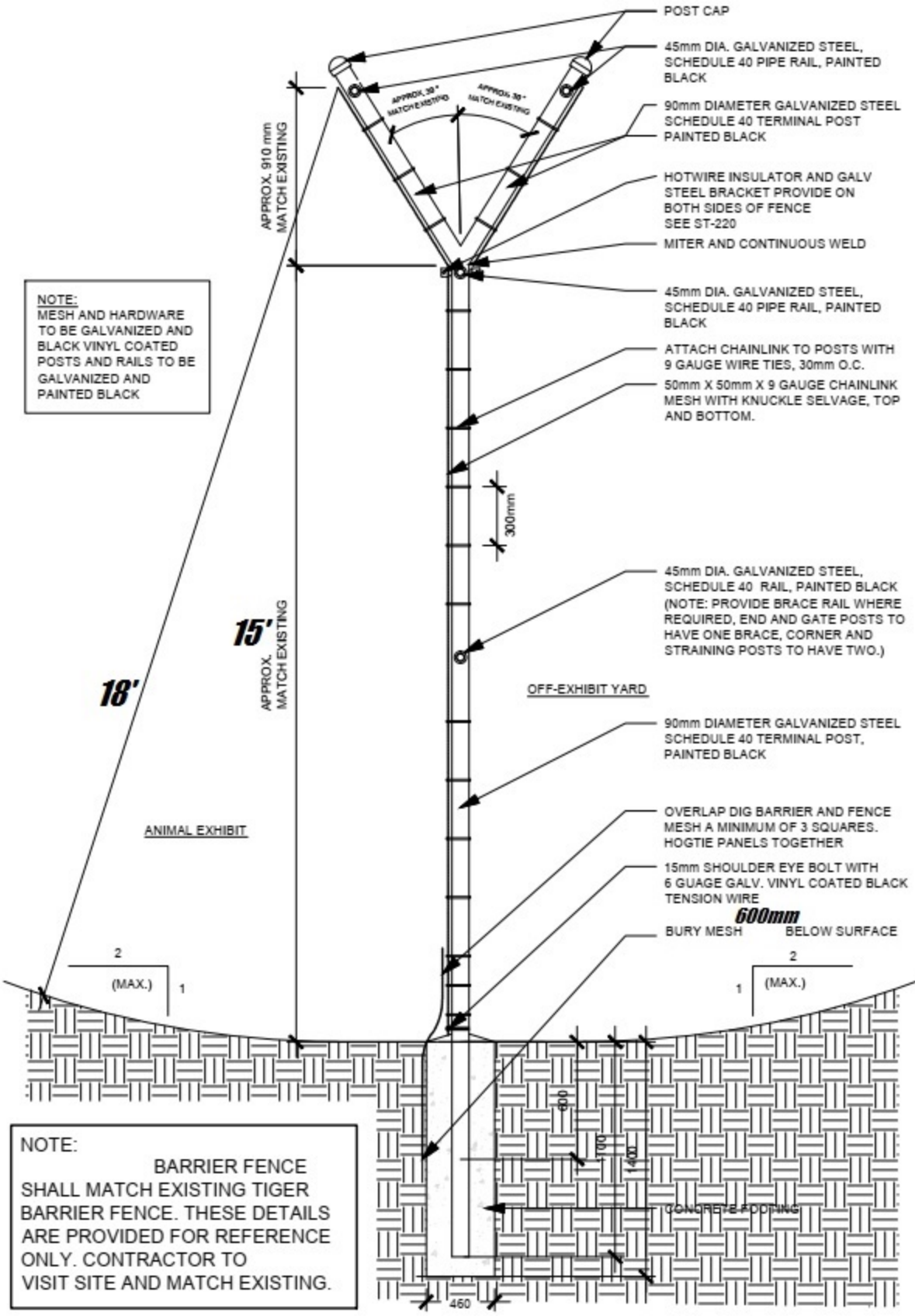

16' High Barrier Fence W/ Double Outrigger Section
SCALE: 1:20

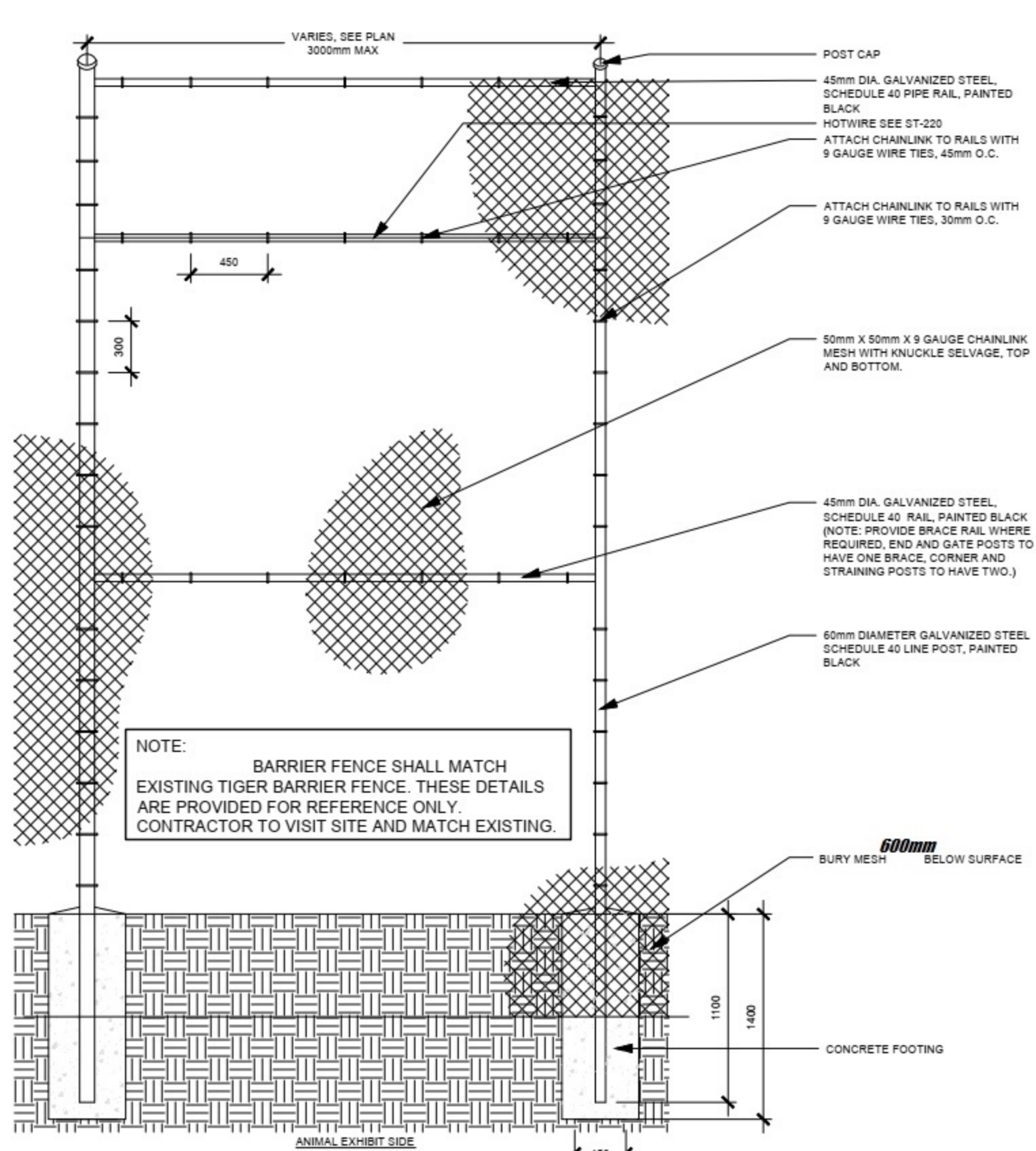

18' High Barrier Fence Elevation
SCALE: 1:20

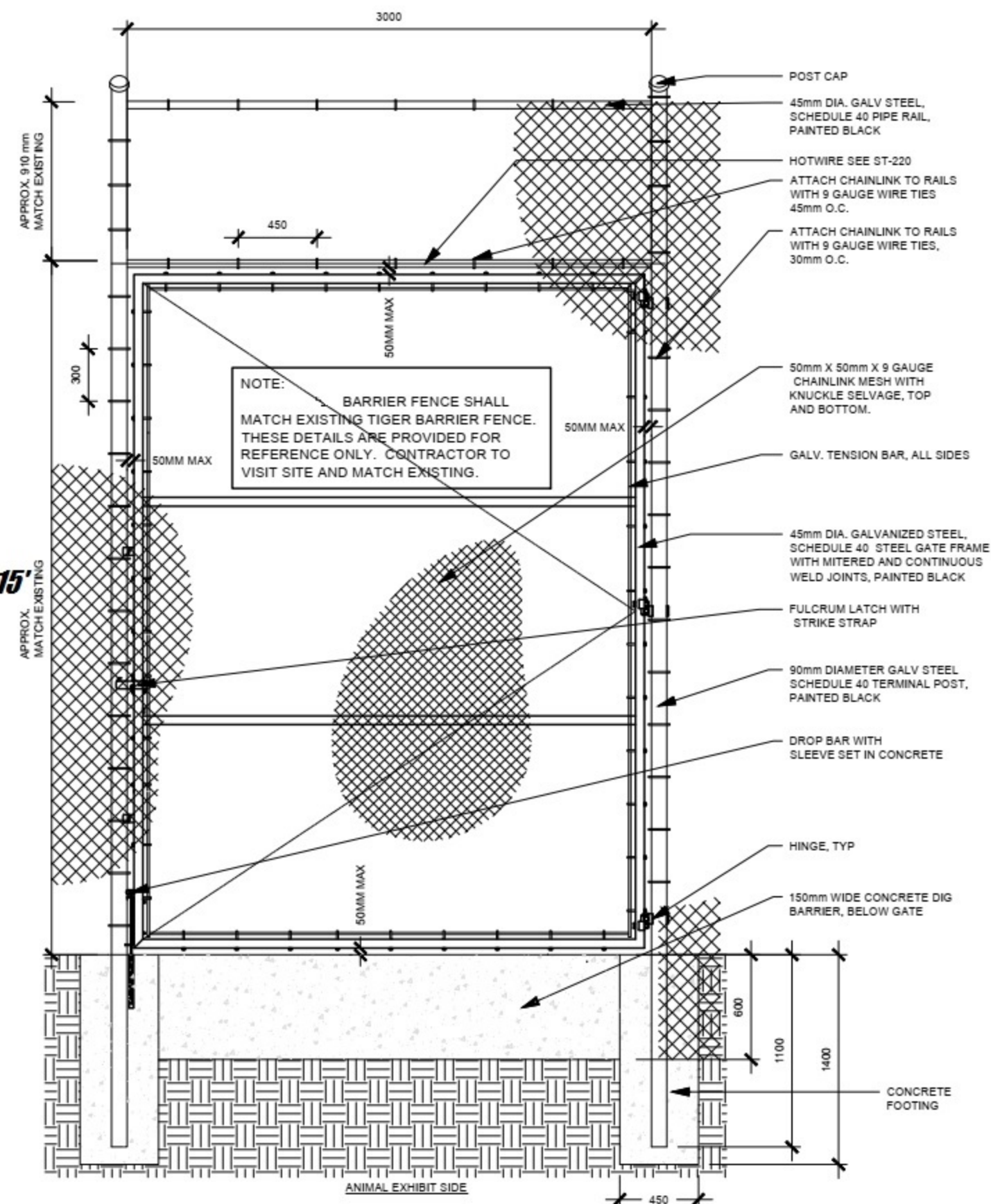

Barrier Fence Gate Elevation
SCALE: 1:20

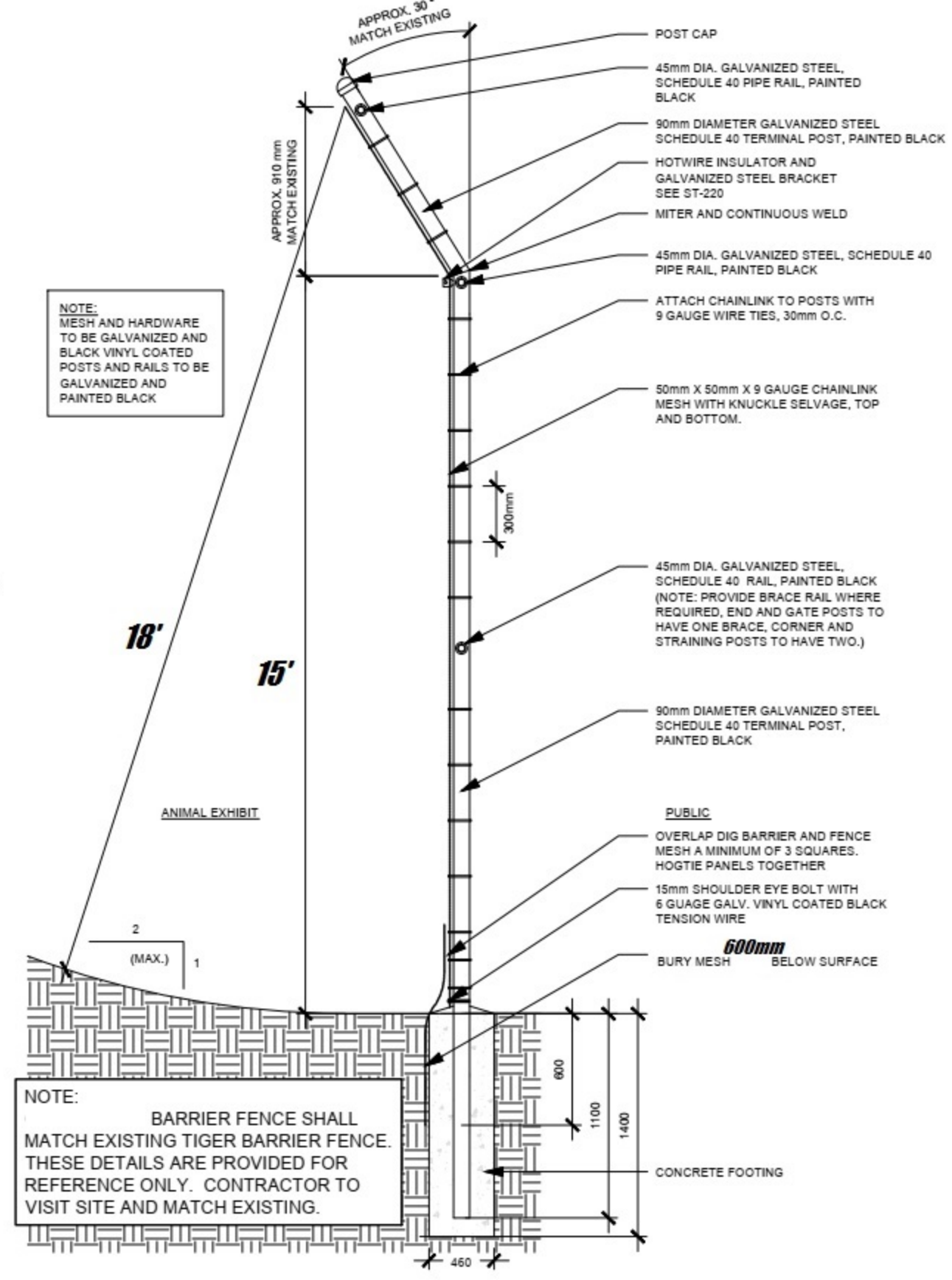

18' High Barrier Fence Section
SCALE: 1:20

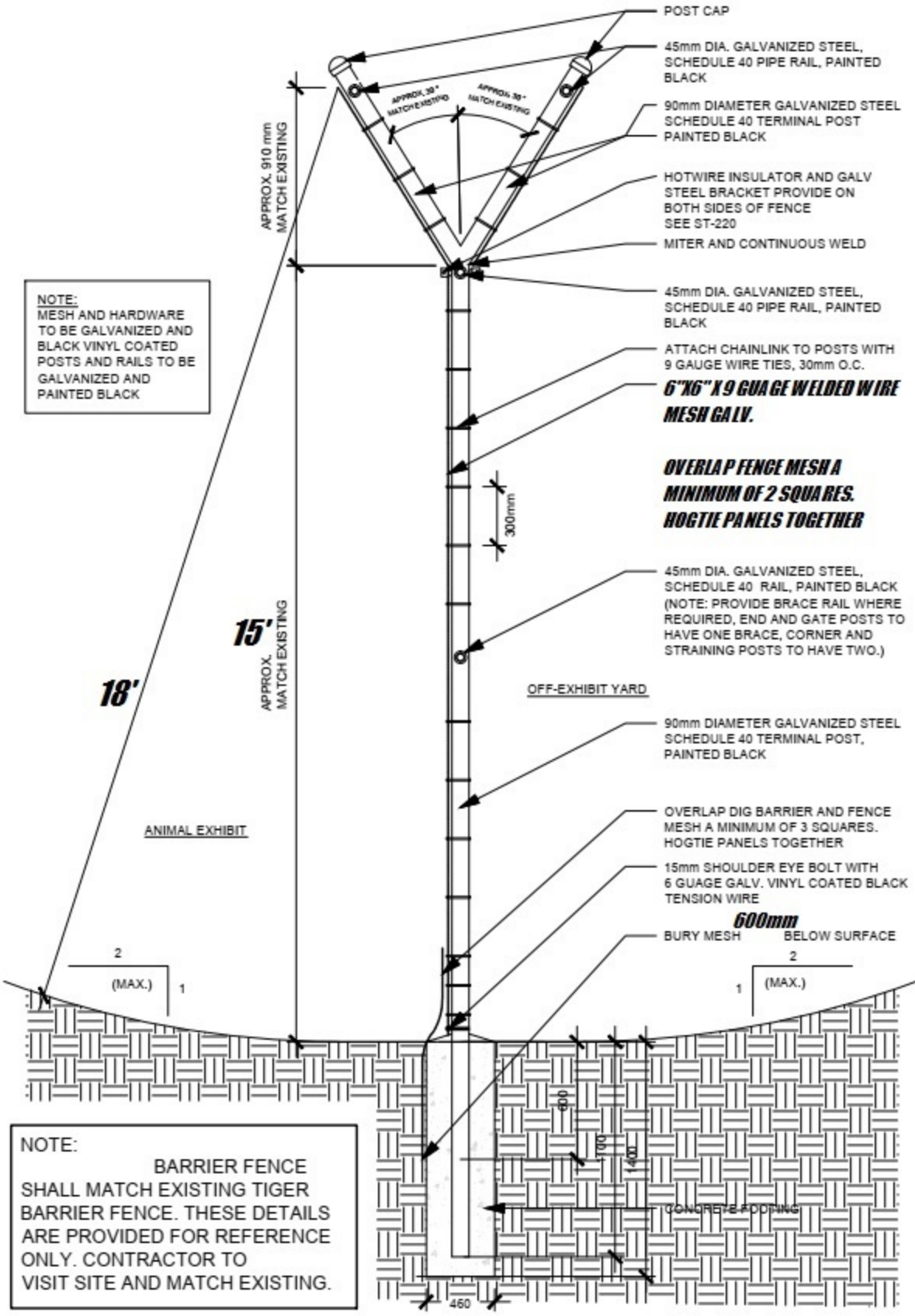

16' High Barrier Fence W/ Double Outrigger Section
SCALE: 1:20

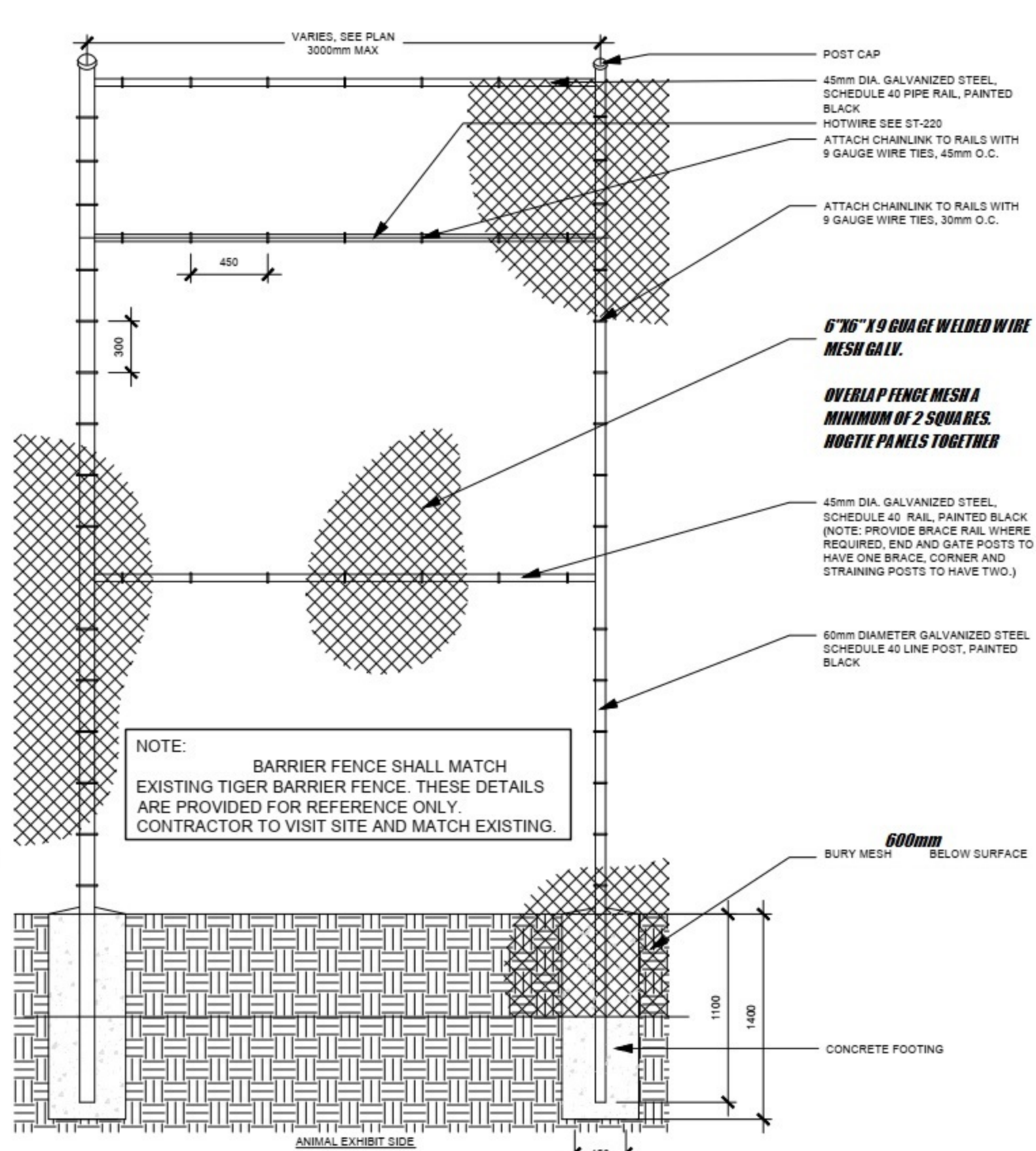

18' High Barrier Fence Elevation
SCALE: 1:20

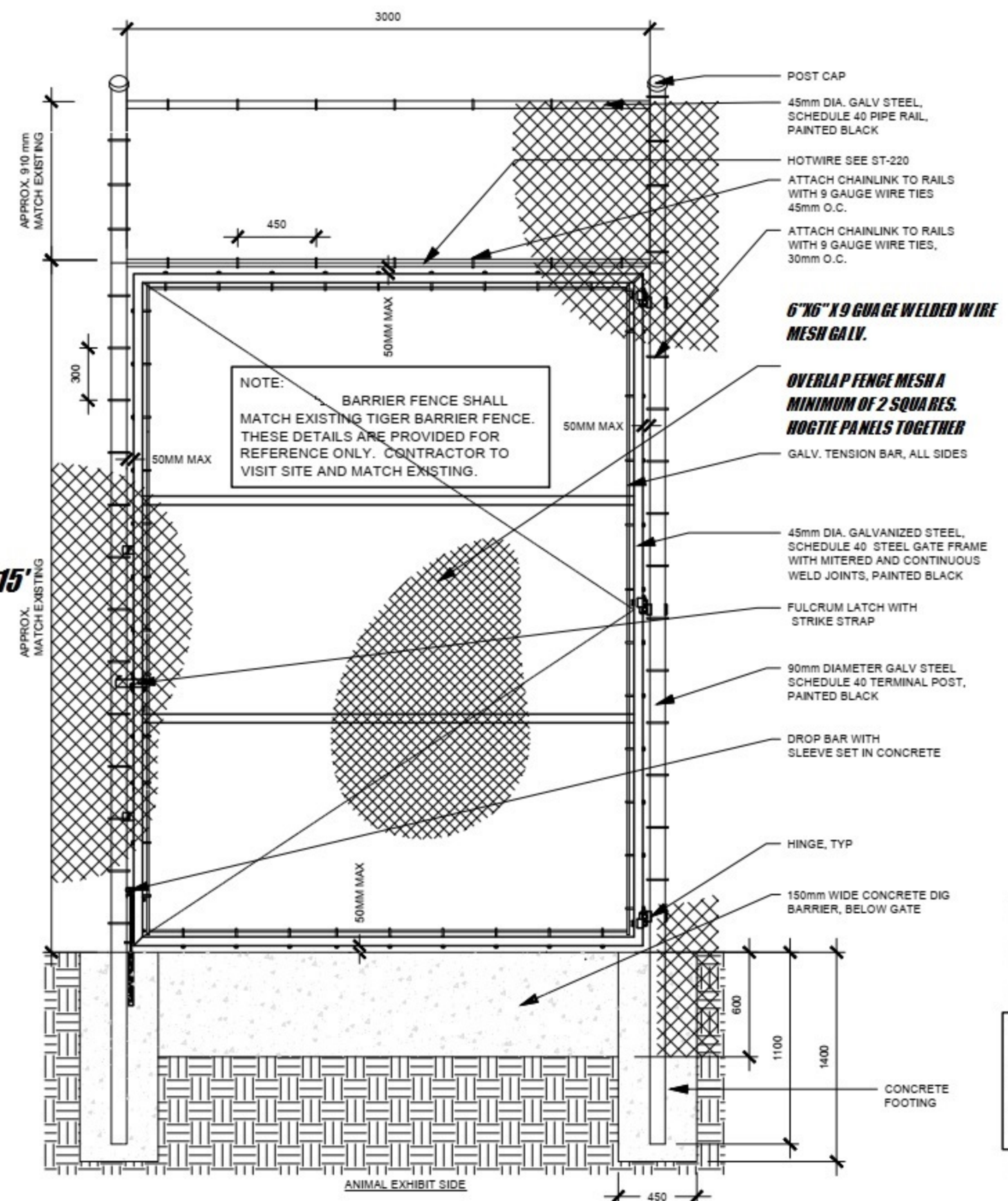

Barrier Fence Gate Elevation
SCALE: 1:20

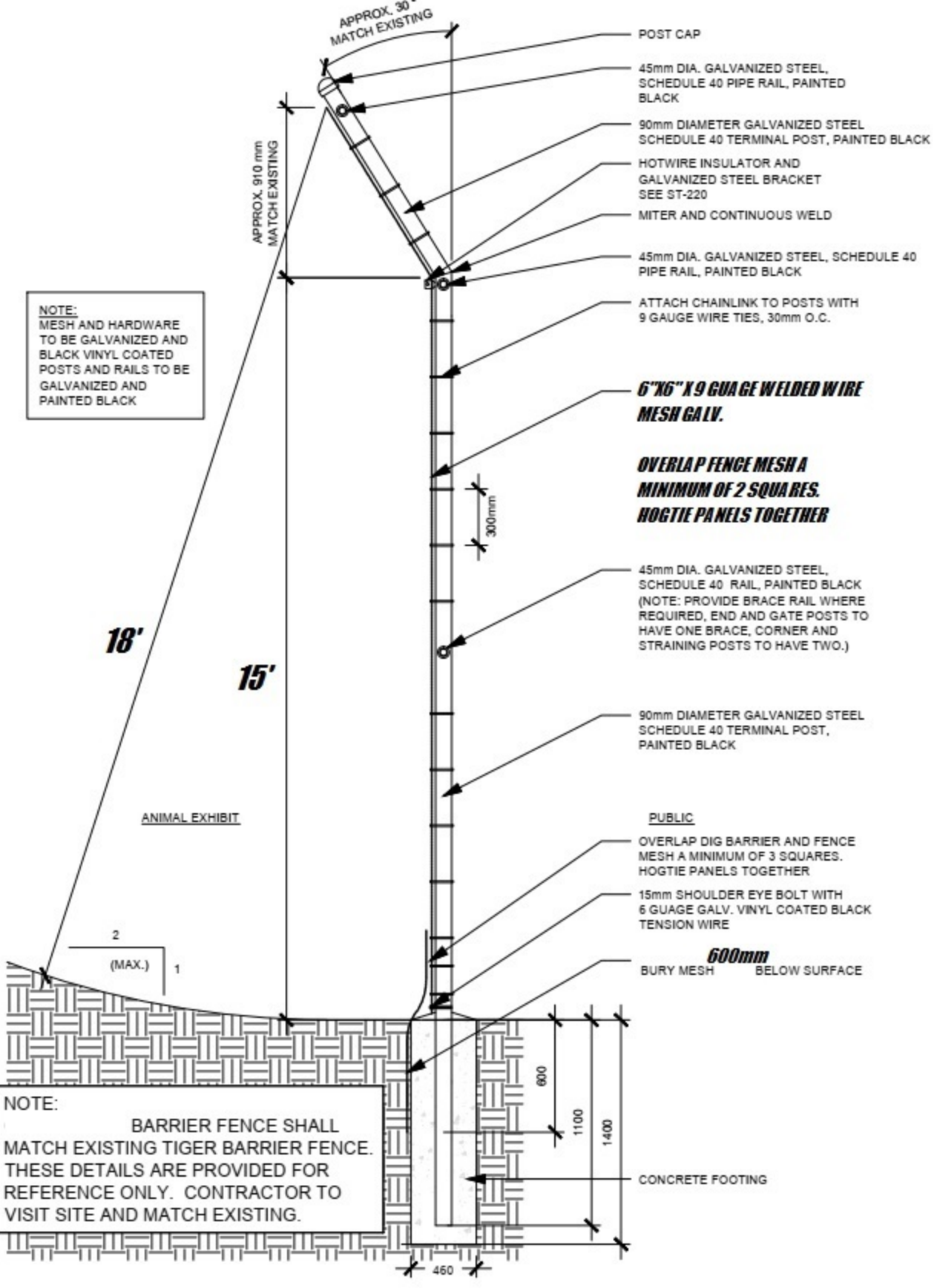

18' High Barrier Fence Section
SCALE: 1:20

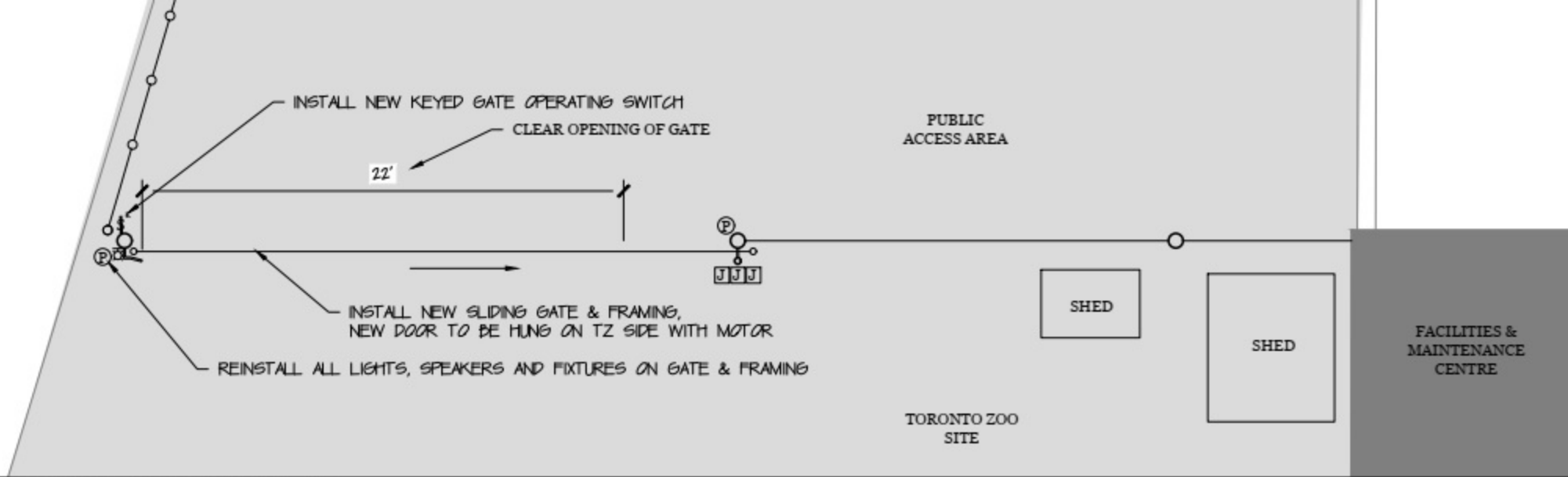

1 D GATE PROPOSED PLAN

SCALE: 3/16" = 1'-0"

LEGEND

Ⓟ SPEAKER

J JUNCTION BOX

Ⓜ EMERGENCY LIGHT

Ⓡ KEYED SWITCH

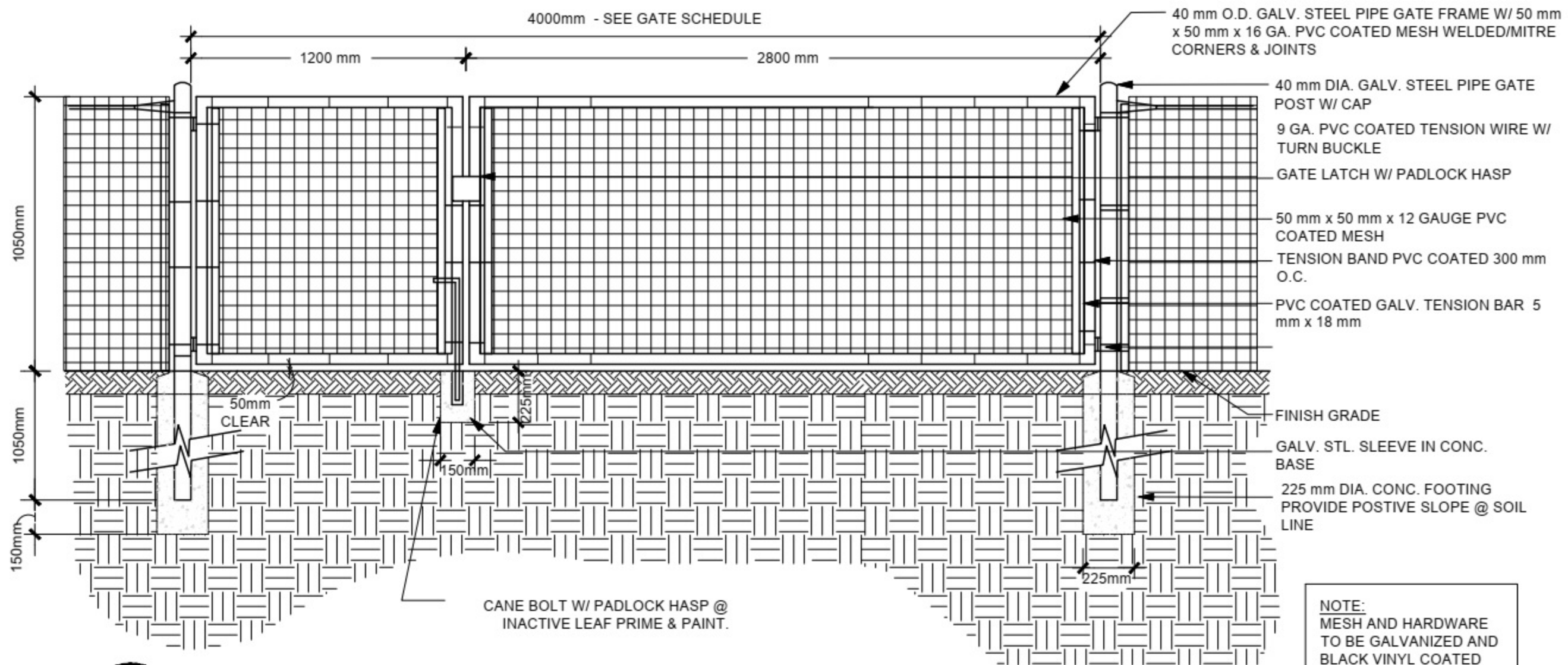

9
ST301

Exclusion Fence - Service Gate

SCALE: 1:10

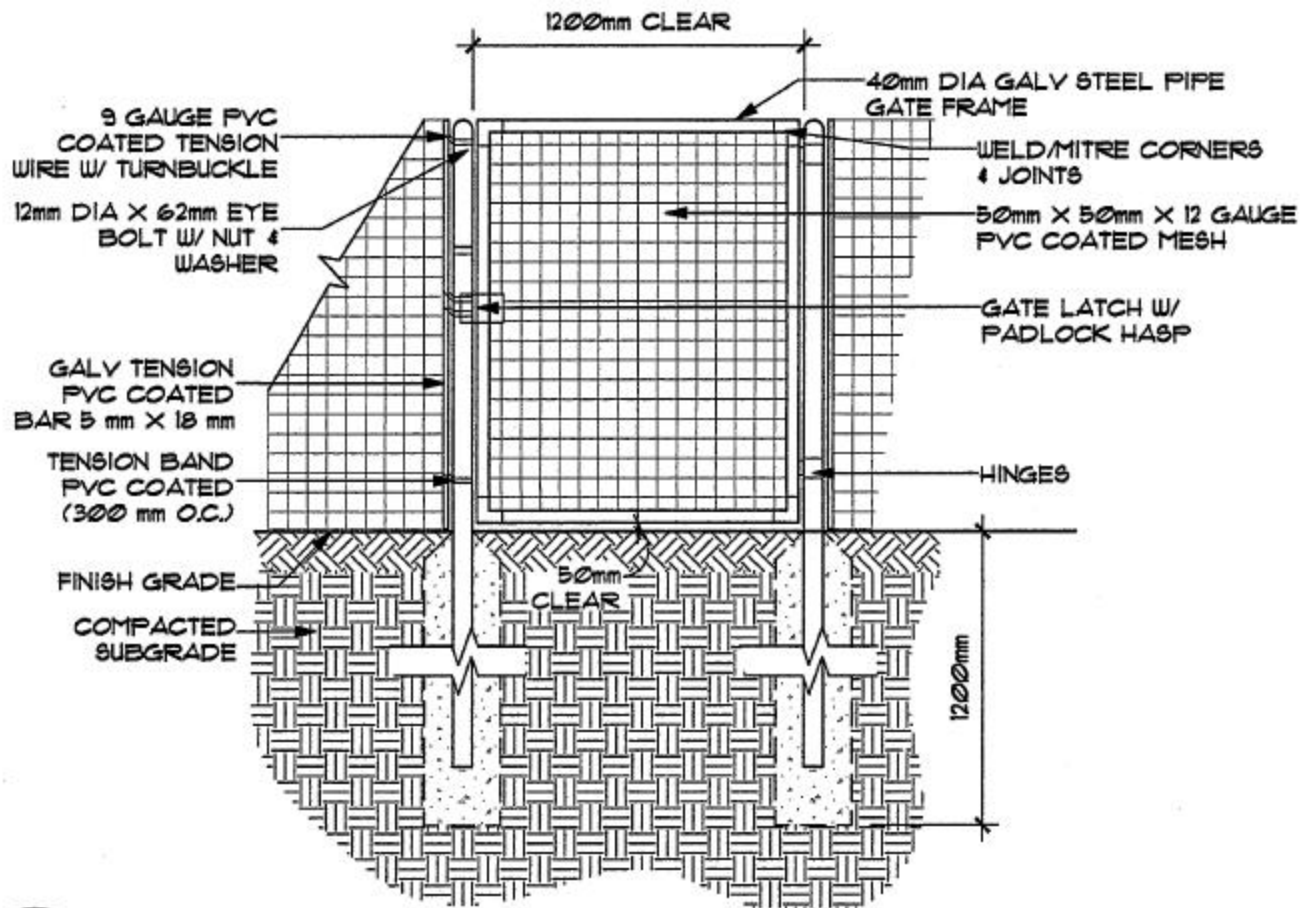

10 EXCLUSION SINGLE SWING GATE

ST-302

SCALE: 1:20

ST-302

SCALE: 1:20

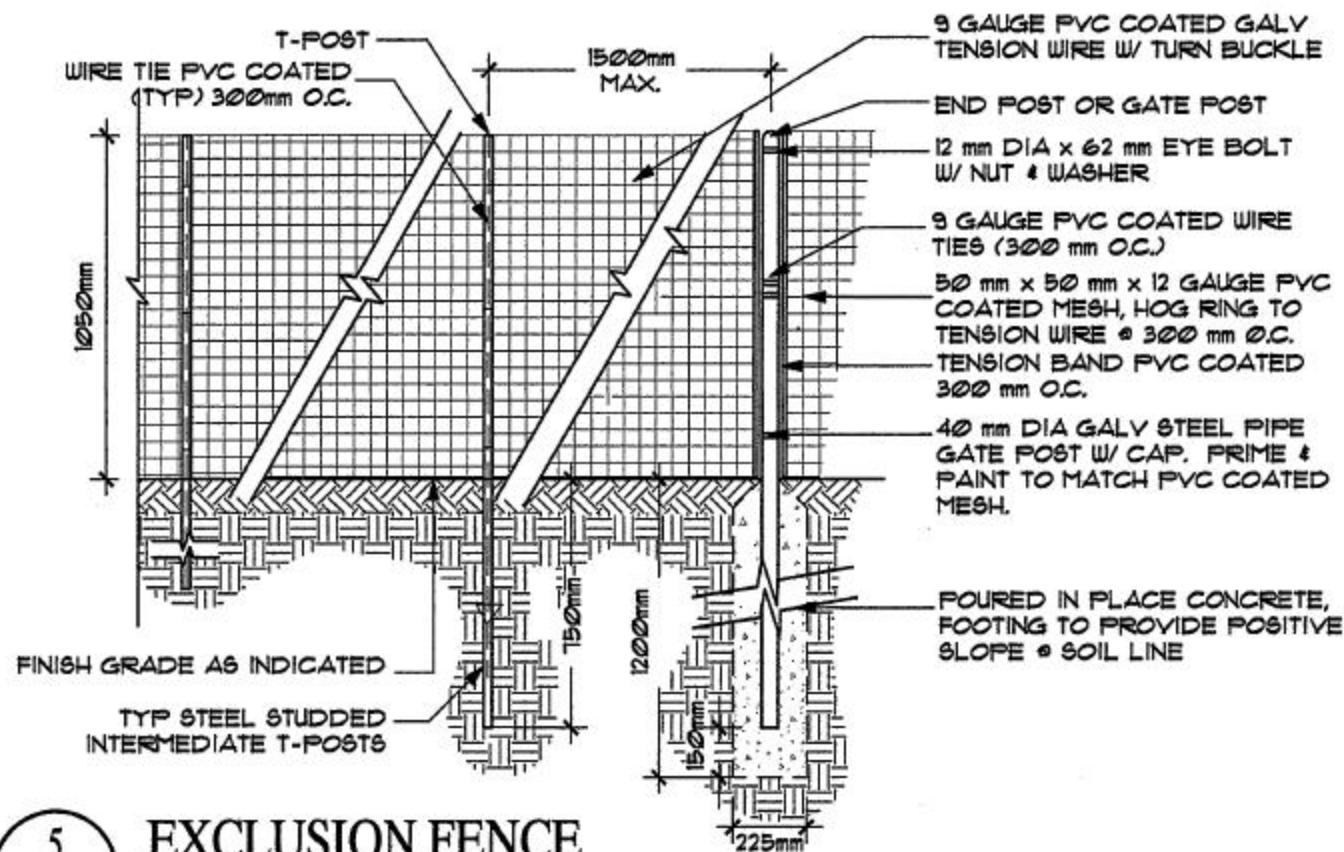

5 EXCLUSION FENCE

ST-302

SCALE: 1:20

VARIABLES - NOT TO EXCEED 8'

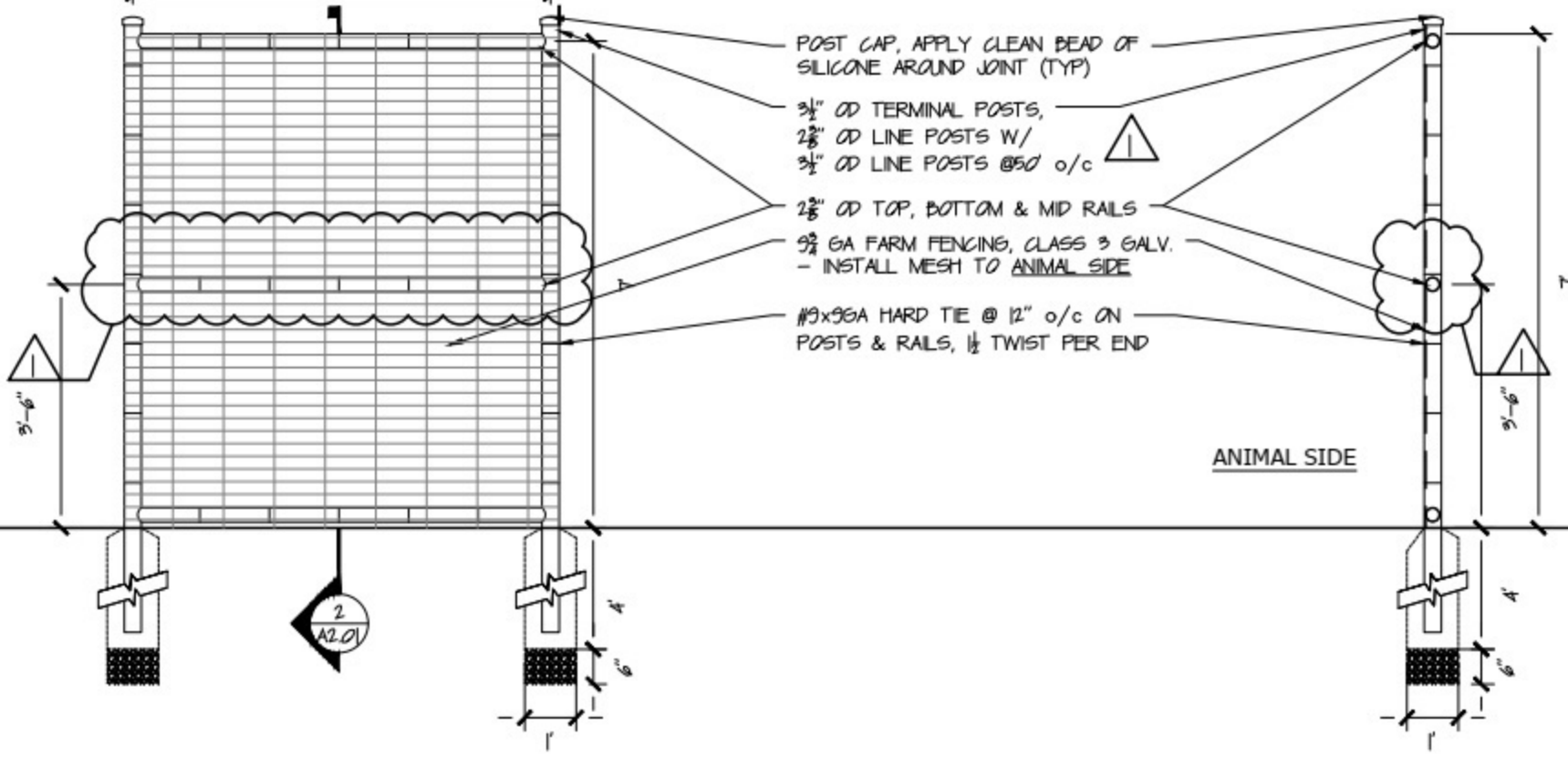

- POST CAP, APPLY CLEAN BEAD OF SILICONE AROUND JOINT (TYP)
- 3/4" OD TERMINAL POSTS,
- 2 1/2" OD LINE POSTS W/
- 3/4" OD LINE POSTS @ 50' o/c
- 2 1/2" OD TOP, BOTTOM & MID RAILS
- 9 1/2 GA FARM FENCING, CLASS 3 GALV. - INSTALL MESH TO ANIMAL SIDE
- #9x9GA HARD TIE @ 12" o/c ON POSTS & RAILS, 1/2 TWIST PER END

ANIMAL SIDE

1 FENCE PANEL ELEVATION (TYPICAL)
SCALE: 3/8" = 1'-0"

2 FENCE PANEL SECTION (TYPICAL)
SCALE: 3/8" = 1'-0"

NOTE:
MESH AND HARDWARE TO BE GALVANIZED AND BLACK VINYL COATED
POSTS AND RAILS TO BE GALVANIZED AND PAINTED BLACK

NOTES:

- ALL FENCE PIPE TO BE SCHEDULE 40.
- ALL FENCE COMPONENTS TO BE GALVANIZED STEEL.
- ALL FENCE HARDWARE TO BE INDUSTRIAL GRADE.
- ALL FENCE AND DOOR FRAMES MIN 1", MAX 2" ABOVE GRADE.
- ALL SYSTEM FASTENERS, SUCH AS NUT SIDE OF BOLT, TO FACE AWAY FROM ANIMAL SIDE. WHERE ANIMALS ARE ON BOTH SIDES FASTENERS MUST BE WELDED. EXPOSED BOLT TIPS MUST BE TRIMMED TO 1/8" PROTRUSION.
- WELD ALL JOINTS, WIRE BRUSH/SAND BLAST WELDS AND COAT WITH ZINC RICH PAINT.
- CHAINLINK MESH KNUCKLE-KNUCKLE
- ALL LINE AND TERMINAL POSTS SHALL BE SET IN CONCRETE FOOTINGS OF THE PROPER DIAMETER AND SHAPE TO ENSURE ADEQUATE SUPPORT. ALL FOOTINGS TO HAVE 6" OF 3/4" CLEAR DRAINAGE GRAVEL BELOW.

MASTER TENDER SPECIFICATIONS

2021-09-226

SECTION 02444 – CHAIN LINK FENCING – PERIMETER FENCE

PART 1 – GENERAL

1.1. General

1.1.1. Conform to General Requirements, Division 1.

1.2. Work Included

1.2.1. Do chain link fencing in accordance with Contract Documents.

1.2.2. Provide and install schedule 40, steel pipe posts, 8' high, 6 gauge, 2" (50mm) chain link fabric and manually operated hinged and latched gates to extent indicated. All mesh, posts, rails, steel and hardware to be galvanized and black vinyl coated.

1.3. Related Work

1.3.1. Cast-In-Place Concrete: Section 03300.

1.4. Quality Control

1.4.1. Company and personnel installing work of this Section shall have a minimum of three (3) years experience in this type of work.

1.4.2. Install chain link fencing in accordance with CAN2-138.3M80 unless otherwise specified hereinafter.

1.5. Submittals

1.5.1. Samples:

1.5.1.1. Submit three (3) samples 12" x 12" in size for review and approval of Consultant. Samples shall show metal wire and wire gauge.

1.5.2. Shop Drawings:

1.5.2.1. Conform to Section 01300.

1.5.2.2. Submit detailed shop drawings of all fencing and horizontal manually operated gates and associated tracks and hardware to Consultant for review and approval prior to commencement of the Work of this Section.

1.6. Warranty

1.6.1. Warranty contained in General Conditions is, with respect to this Section of Work, extended from one (1) year to three (3) years. Without restricting generality of warranty, defects shall include galvanizing of posts, fabric loosening etc.

MASTER TENDER SPECIFICATIONS

2021-09-226

SECTION 02444 – CHAIN LINK FENCING – PERIMETER FENCE

PART 2 – PRODUCTS

2.1. Materials

- 2.1.1. Unless specifically noted on drawings all chain link fencing is to meet the following standards:
 - 2.1.1.1. All mesh, posts, rails and hardware to be galvanized and black vinyl coated.
 - 2.1.1.2. All terminal posts, gate posts, line posts, top rails, braces and centre rails shall be Schedule 40 pipe. Top rail installed using line post cap. Centre / brace rails installed using rail end caps and centre / brace bands with 5/16” nuts and bolts.
 - 2.1.1.3. Terminal and gate posts to be 3-1/2" O.D., Schedule 40, 3" longer than the height of the fabric.
 - 2.1.1.4. Line posts to be 2-3/8" O.D., Schedule 40 pipe
 - 2.1.1.5. No tubing, conduit or open seam material is to be used. Maximum spacing of line posts to be 10'.
 - 2.1.1.6. Fabric to be installed in the ground 2” with the top 2 x 2 link centered on the top rail.
 - 2.1.1.7. All posts to have concrete footings to minimum of 4'-0" below finished grade. All post footings to be 12" diameter.
 - 2.1.1.8. All fences to have top rail of 1-11/16" O.D., Schedule 40, pipe.
 - 2.1.1.9. All fences to have 6 gauge bottom wire attached with twist ties every 12”.
 - 2.1.1.10. For single gate openings up to 10' or double gate opening up to 20', gate posts to be 3-1/2" O.D. For single gates 10' to 14', or double gates 20' to 28', gate posts to be 4-1/2" O.D.
 - 2.1.1.11. All gates to be hinged using three heavy duty, bolted both ends, post collars and 3/4” hinge bolts. Gates to be latched using heavy duty, post collars, frame collars and drop latches.
 - 2.1.1.12. Terminal posts to be topped by 3-1/2" post caps.
 - 2.1.1.13. Where barbed or "hot" wire is to be installed to top of fencing, terminal posts to have 3-1/2" barbed wire arm, line posts to have 2-3/8" barbed wire arm. All terminal and gate posts to be secured to fabric with tension bars and 3-1/2" or 4 1/2” tension bands at 16" intervals.

MASTER TENDER SPECIFICATIONS

2021-09-226

SECTION 02444 – CHAIN LINK FENCING – PERIMETER FENCE

2.1.2. Gates

- 2.1.2.1. Gates to have steel frames 1-11/16" O.D., 2" (50mm), 6 gauge, chain link, with fence fittings for padlock and hinges. Welded on fittings will require prior approval from Zoo staff.
- 2.1.2.2. Tension bar to be 3/16" x 13/16" steel. Fabric fasteners to be single strand, 9 gauge, aluminium "HARD" wire ties, conforming to requirements of fence fabric.
- 2.1.2.3. Fittings and hardware to be galvanized or cast aluminium alloy. Post caps to provide waterproof fit to fasten securely over posts and to carry top rail.
- 2.1.2.4. 2" (50 mm) sphere test chain link fence, top and bottom links centred on pipe, 6 gauge size.

PART 3 – EXECUTION

3.1. Installation

- 3.1.1. Install corner posts with tension bars and tension bands where change in alignment exceeds 20°.
- 3.1.2. Install end posts at end of fence and at buildings. Install gate posts on both sides of gate openings.
- 3.1.3. Place posts in the holes then embed posts in concrete to minimum 3'-6" depth. Top of concrete 6" down from finished grade. Post holes should be square sided to discourage frost interference. Brace to hold posts in plumb position and true to alignment and elevation until concrete has set.
- 3.1.4. Do not install fence fabric until concrete has cured a minimum of 5 days or until concrete has set to hold the force being applied by the attachment of the fabric.
- 3.1.5. Install a brace, using the appropriate fittings, between top of terminal and gate posts and the bottom of the nearest line post. Install braces on both sides of corner and straining posts in similar manner. Install 1-11/16 O.D., Schedule 40 galvanized.
- 3.1.6. Where necessary a welded both ends angle brace that runs from the top of the terminal or gate post to the bottom of the adjacent line post may be required. To be determined and entered into the specification list for that particular contract.
- 3.1.7. Install top rail over line posts and fasten securely to end posts with water proof caps.

MASTER TENDER SPECIFICATIONS

2021-09-226

SECTION 02444 – CHAIN LINK FENCING – PERIMETER FENCE

- 3.1.8. Lay out fence fabric. Stretch tightly to tension recommended by manufacturer and fasten to end, corner, gate and straining posts with tension bar secured to post with tension bands, spaced at 16” intervals and 5/16” nuts and bolts.
- 3.1.9. Secure fabric to top, centre and brace rails and line posts with tie wires at 12" intervals, using 9 ½” long x 9 gauge aluminium “HARD” tie wires minimum 1 ½ twists. per end are required.
- 3.2. Gates
 - 3.2.1. Install manually operated hinges and latches in a rigid and secure manner complete with all necessary associated hardware.
 - 3.2.2. Set gate bottom approximately 2" above ground surface.
 - 3.2.3. Adjust hardware and gates to operate smoothly to Consultant's approval.
- 3.3. Fabric Extensions
 - 3.3.1 Using pipe extend terminal, gate and line posts as required to re-establish minimum 8’ height using an internal pin support that closely matches the interior diameter of the existing post and the added extension post.
 - 3.3.2 Internal pin should extend 12” into both the existing post and the added extension and be held in position by spot welds in drill holes through the exterior layers of pipe.
 - 3.3.3 The joint between the extension and the existing pipe shall be fully welded and water tight around its circumference.
 - 3.3.4 After welding joints will be painted with a galvanizing paint.
 - 3.3.5 Additional 6 gauge 2” (50mm) weld mesh will be added allowing for a minimum 2” over lap over the existing fabric and attached to a 6 gauge bottom wire secured by twist ties every 12” that bind the two mesh fabrics and the added bottom wire together.
 - 3.3.6 Termination posts for extensions should match existing post diameter and braced to the nearest line posts. Braces run from the top of the termination post to bottom of the nearest line post, using 1 11/16” diameter pipe, brace bands and rail end caps.

MASTER TENDER SPECIFICATIONS

2021-09-226

SECTION 02444 – CHAIN LINK FENCING – PERIMETER FENCE

3.4 Additional Fabric Support

- 3.4.1 Dig soil around existing fabric and re-attach same to existing posts with wire ties and bottom wire as previously described.
- 3.4.2 Where indicated install additional line posts in line with and centred between existing posts attached as previous described.
- 3.4.3 All additional posts to be attached to the head-rail, bottom wire and tied as per previous instructions.

3.5 Clean-Up

- 3.5.1 Promptly as the work proceeds and on completion, remove all rubbish and debris from the building site, resulting from the foregoing work. Level ground and remove excess soil.

END OF SECTION



Rouge Creek

Meadowdale Rd

Meadowdale Rd

Meadowdale Rd

Meadowdale Rd

Zoo Rd

Zoo Rd

Zoo Rd

Zoo Rd

Zoo Rd

Rouge Valley Conservation Centre

Vista Trail Trailhead, Rouge National Urban...

Rouge National Urban Park
Wilderness area with diverse landscapes